



Factron
A BETTER SOLUTION

QHC06MRE 6kW RF Heater Controller (Receiver)

QHC06MRE



QHC06MRE

Single Phase 240v / Single Channel / Soft Start

Remote Operation

Quick Start for QHC06MRE 6kW RF Heater Controller (receiver)

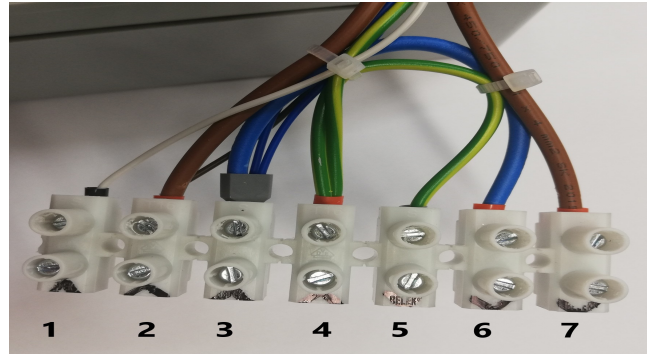
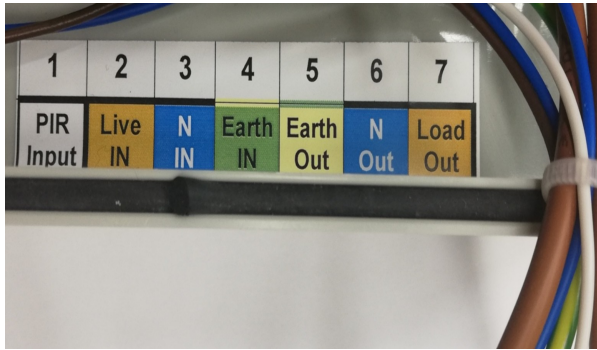

- 1) Remember isolate the Mains before removing the cover. Remove the cover by removing the 4 screws. There is a terminal strip connector for connecting the Mains IN and Mains OUT.
- 2) Use the three cable glands to bring the Mains cables into and out of the controller base .
- 3) Connect Mains IN - Live brown (2), Neutral blue (3) and Earth green/yellow (4) wires to terminals marked Live IN (2), N IN (3) and Earth IN (4).
- 4) Connect the Infrared Heater - the brown Live wire to Load Out (7), the blue Neutral wire to N Out (6) and the green/yellow Earth wire to Earth Out (5).
- 5) The trigger from a motion detector (PIR) QHPIR is connected to terminal PIR Input (1).
- 6) When all connections are complete and connected correctly, check once again that the wiring is correct as per 3) & 4). Then replace the cover and tighten the fixing screws.
- 7) Turn ON or reconnect the Main Power to the controller. The red neon lamp on the LHS will illuminate to indicate that the unit is **LIVE**.

The controller is now ready to be controlled by the wireless remote unit **QHVCR**. See instructions for QHVCR operation, page 2 follow steps 8) to 14).

**Remember to fit Type C MCB or RCBO circuit breakers
or a fused spur for each heater.**

QHVC R 3 Zone Remote Master Controller (transmitter)

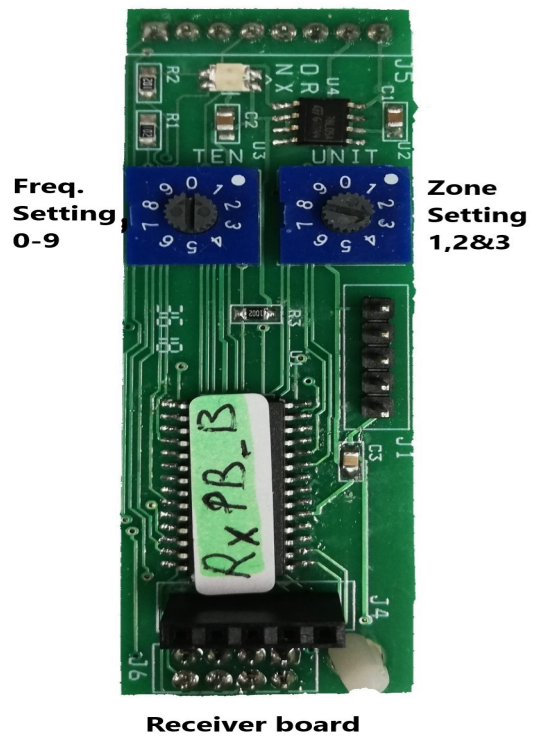

- 8) There are three control dials Blue, Yellow & Red one for each zone. The QHC06MRE units are preset to operate in one of these zones. The QHC06MRE unit once preset will only operate in that designated zone. The factory setting is 1, this will be the Blue control dial.
- 9) Turn ON the QHVCR unit by pressing the ON/Standby button on the front panel. The Led indicator will flash orange – green – orange – green and remain Green to indicate that the unit is ready.
- 10) The QHC06MRE unit is preset as a Blue zone (1). Turn the Blue control dial to position 1. The heaters connected to the QHC06MR units will come ON at the minimum setting 33%. Continue to turn the Blue control dial through position 2 to 4 until you reach the desired setting. Settings are **OFF** = 0%, **1** = 33%, **2** = 50%, **3** = 66% & **4** = 100%.
- 11) QHC06MRE units which are preset to Yellow & Red zones are controlled by the Yellow & Red control dials respectively and will operate as above in 10).
- 12) The QHVCR unit is powered by 3 x AAA battery's. So, the unit will automatically go into standby mode if the unit is inactive for more than 30 seconds. When the unit goes into standby mode all the QHC06MR units will remain unchanged at the settings they were set at. The heaters will remain ON.
- 13) To change a setting just press the ON/Standby button and proceed as described in 9) & 10). However, while the QHVCR unit is ON, you can turn OFF all the heaters by pressing the ON/Standby button. This is indicated by the Led indicator flashing Red.
- 14) The previous settings will be remembered and will be restored when you press the ON/Stand by button again.
Please note that the QHVCR remote Master Controller can control any number of QHC06MRE & QHC09MRE controllers. Once they are within range of up to 100 meters * (see specification sheet for the QHVCR unit).

Pairing (programming) Devices QHVCr & QHCxxMR & MRE

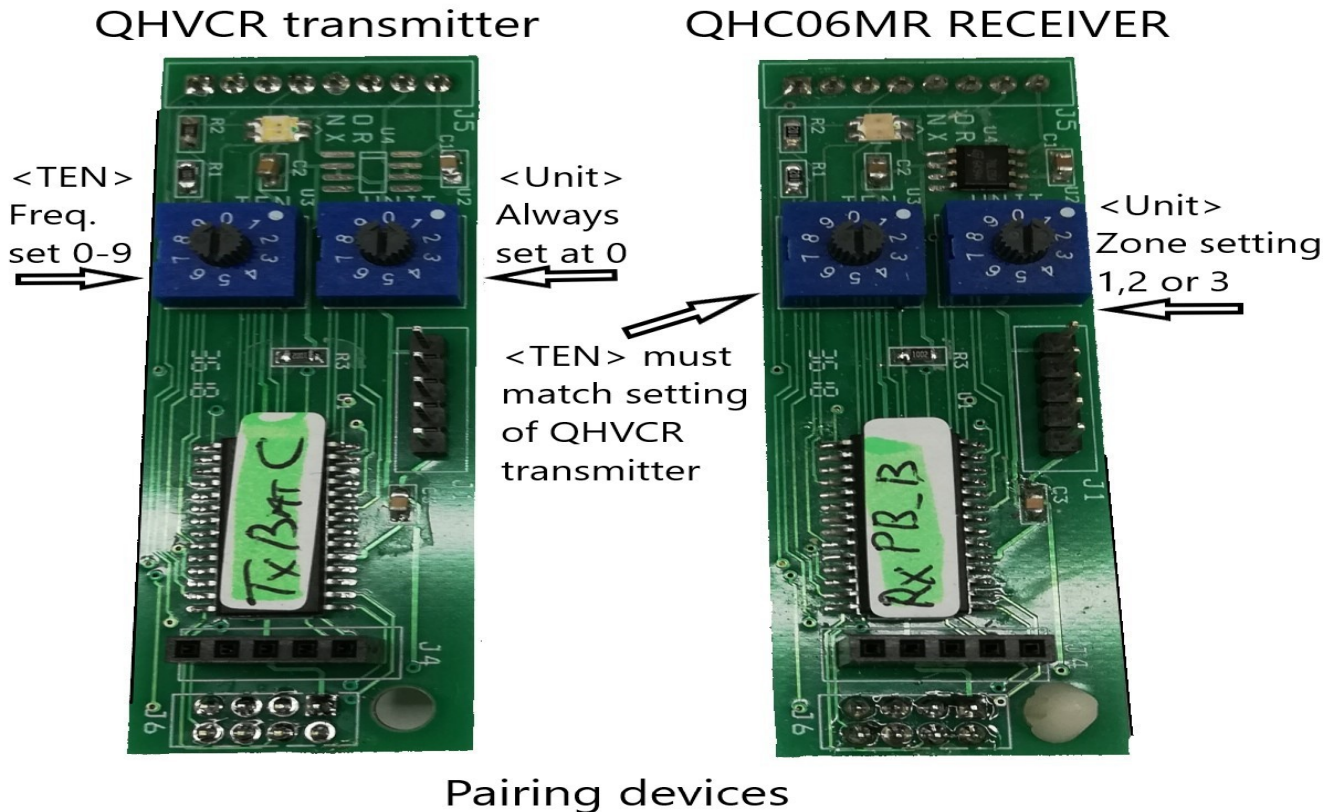

Pairing (programming) devices QHVCR (transmitter) and QHCxxMR (receivers).

- 1) The Left Hand Side rotary switches (TEN) on both boards must be set the same. The LHS switch (TEN) is used to set the RF frequency the setting must match on both boards. There are **10** possible frequencies that can be selected **0-9**. If the settings on the LHS switch (TEN) do not match the devices will fail to operate.

Designating the transmitter and receiver. Both the left rotary switches are set at **0**, this ensures that the transmitter marked **0** will communicate with the receiver marked **0**. Setting the left rotary switch to **1**, so the transmitter marked **1** will communicate with a receiver also marked **1**.

If the transmitter and receiver are not paired correctly they will not communicate and therefore will not operate; transmitter marked **0** will **not communicate** with a receiver marked **1**.

Remember a transmitter can be set at any number between **0-9** & the receiver must be matched correctly.

- 2) The Right Hand Side rotary switches (UNIT) are for setting the device to operate in a set zone. There are 3 possible zones that the controller can be set to. The RHS switch (UNIT) should be set to 1,2 or 3.

Blue Zone 1 operation set RHS switch (UNIT) to **1**

Yellow Zone 2 operation set RHS switch (UNIT) to **2**

Red Zone 3 operation set RHS switch (UNIT) to **3**

PIR motion detector (QHPIR) fitting

QHC06MRE & QHC09MRE

PIR motion detector
230v operation
QHPIR



PIR motion detectors are passive infrared sensors an electronic device which is triggered by infrared light from the movement of objects in it's field of view. A PIR can be connected to a QHC06MRE controller.

This will enable the controller to turn ON the heaters only when the presence of a person or people are detected by the PIR.

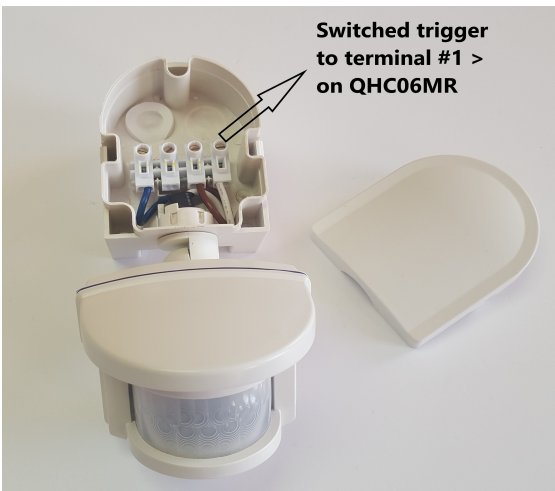

The angle of the PIR and the viewing width of the lens will have to be adjusted to ensure the detection area is that which is required. Full lens width will have a large detection area. For a smaller area the lens narrow the lens using the lens mask.

Setting the Lens width correctly is crucial, if this is set incorrectly the PIR could be continuously be ON. This can cause the heaters to remain ON too.

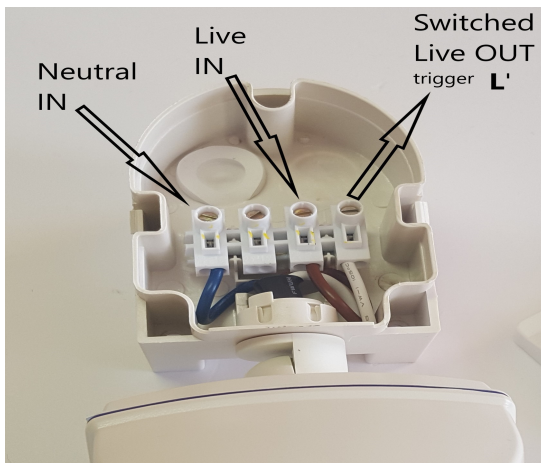

Connect the switched trigger to terminal #1 PIR Input on the QHC06MR controller.

The switched Live OUT to the QHC06MRE controller is a Live 240V feed, this is only used as a signal Input to the controller.

The Live and Neutral must be the fixed 230V AC. Terminals #2 (Live) & #3(Neutral).

7-Day programmable timer fitting option

A 7-Day programmable timer can be fitted as an option instead of the PIR. It is important to note that only one or the other can be fitted to the QHC06ME controller **not both**.

S1 & S2 are found on the printed circuit board (PCB) QHPCB-A, See fig 12

Default settings for S1 & S2

Remote **OFF** – **S1** Jumper is factory set in the Off position pins 2 & 3,. For Manual operation.
 PIR & 7-Day Timer **OFF** - **S2** Slide switch is factory set in the Off position “2”. See Fig 12

To set up for a 7-Day programmable timer

S2 Slide switch must be set in the ON position “1”, See Fig 12

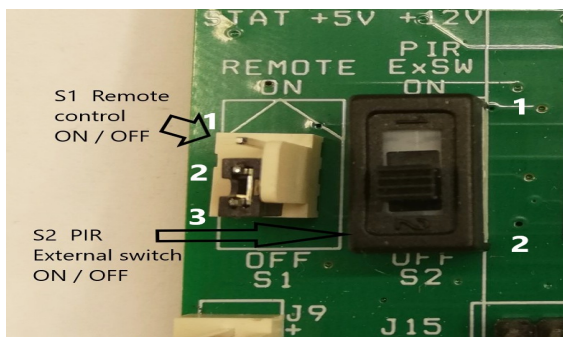
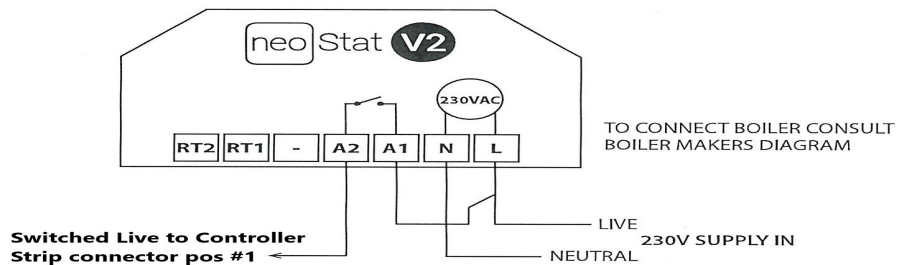

Fig 12 Slide switch S2 OFF position

Fig 13 Typical 7-Day Programmable Timer

Wiring Diagram - neoStat to QHC06M Controller



This product must only be installed by a qualified electrician and comply with local installation regulations.

Fig 14 Wiring connection to the QHC06M controller

The switched Live through A2 terminal on the 7-Day timer is connected to position 1 on the strip connector of the QHC06M controller See Fig 1,2 & 14.

Once the 7-Day programmable timer is fitted correctly it will now control when the controller will be ON or OFF.

This function can be disabled by simply switching the S2 slide switch back to the OFF position 2 See Fig 12

Expandable heating system using a QHVCR & multiple QHC06MRE, QHC09MRE, QHC12MRE & QHC18MRE.

Using the remote 3 zone QHVCR controller the area being heated can be zoned into three area's Blue, Yellow & Red. Each zone can be controlled separately, this includes setting each zone at a different level. There are 5 setting levels > Off - 1 (33%) - 2 (50%) - 3 (66%) - 4 (100%).

Any combination of our QHC controllers can be used in the proposed zoned layout below. There are 6kW QHC06MRE, 9kW QHC09MRE, 12kW QHC12MRE & 18kW QHC18MRE controllers available to be used depending on the over all number of heaters required.



Blue zone 6kW controller set a (0) > 0-1

Blue zone has 3 x 2kW heaters Total 6Kw

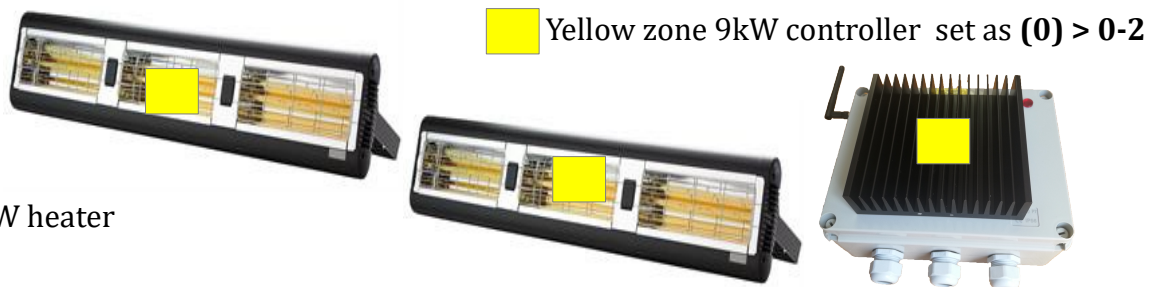

Yellow zone 9kW controller set as (0) > 0-2

Yellow zone has 2 x 4.5kW heater Total 9kW

Red zone 18kW controller set as (0) > 0-3



Red zone has 1 x 12kW heater Total 12kW

Remote 3 zone QHVCR controller set as an (0) > 0

This configuration allows the heaters in the Blue zone be controlled by the 1st dial on the remote control, setting levels at Off to 4. The Yellow zone is controlled by the 2nd dial & the Red zone is controlled by the 3rd dial.



For larger installations multiple controllers and heaters can be added to each zone where required.

It is recommended that each heater should be fused with a spur. Each controller should have a Type C MCB circuit breaker and the whole installation must have an Isolation switch.

Troubling shooting

- 1) The QHC06ME (receiver) is not working.

Check that the unit is wired correctly and follow the installation procedure on page 1. The neon indicator should be ON to indicate the the Mains is connected correctly.

Then check that the status LED D5, the +5v LED D6 & the +12v LED D7 are all ON green. If the status LED is Red, this indicates that there is a problem with the mains connection to the board.

If the +5v or +12v LEDs are Red this indicates that there is a problem with the processor chip or a power supply problem.

- 2) There is no communication between the QHC06MRE & QHVCR

The units may not be paired correctly. First determine what frequency the QHVCR is set at. The setting is marked at the back of the unit. If it's marked **(0)** you must check to see if the QHC06MR is also set the same and is also marked **(0)**. If they are different then the controller QHC06MR will not work.

If needed you can reset the controller QHC06MRE by following the Pairing instructions on page 3.

- 3) Paired transmitter QHVCR & receiver QHC06MRE still won't communicate even when they are both set the same. The small antenna RF PCB could be the problem. Check if the small LED flashes Red when the transmitter QHVCR is turn ON & OFF. The communication is good between the two units when the LED flashes Red. Otherwise if the LED remains ON Green then the RF PCB is faulty and needs to be replaced.

However, if the RF PCB is working and the LED flashes Red but the controller QHC06MR is still not working. The cable connection between the RF PCB and the Antenna could be faulty and may need to be replaced.

- 4) Yellow zone is not working !

The problem could be the receiver is set as a blue zone or red zone. If this is the case all you have to do is re-set the right hand rotary switch to position 2. See page 3

- 5) Circuit Breaker MCB keeps tripping when the heaters are turned ON !

Ensure that the MCB is a Type C curve due to high IN RUSH currents. A common fault is to use Type B but these will always fail. Replace with Type C and the problem should be fixed. Also, if using RCBO's again Type C curve must be used. In some case's you will have to use the double module version of an RCBO similar to that shown on page 13.

The RCBO's are more sensitive & D Type may have to be used instead !!

- 6) If the controller does not respond to settings 3 & 4.

Check the for a loose or missing Black connector ref. J8 (TMP2) header on the printed circuit board (PCB).

Wiring diagrams

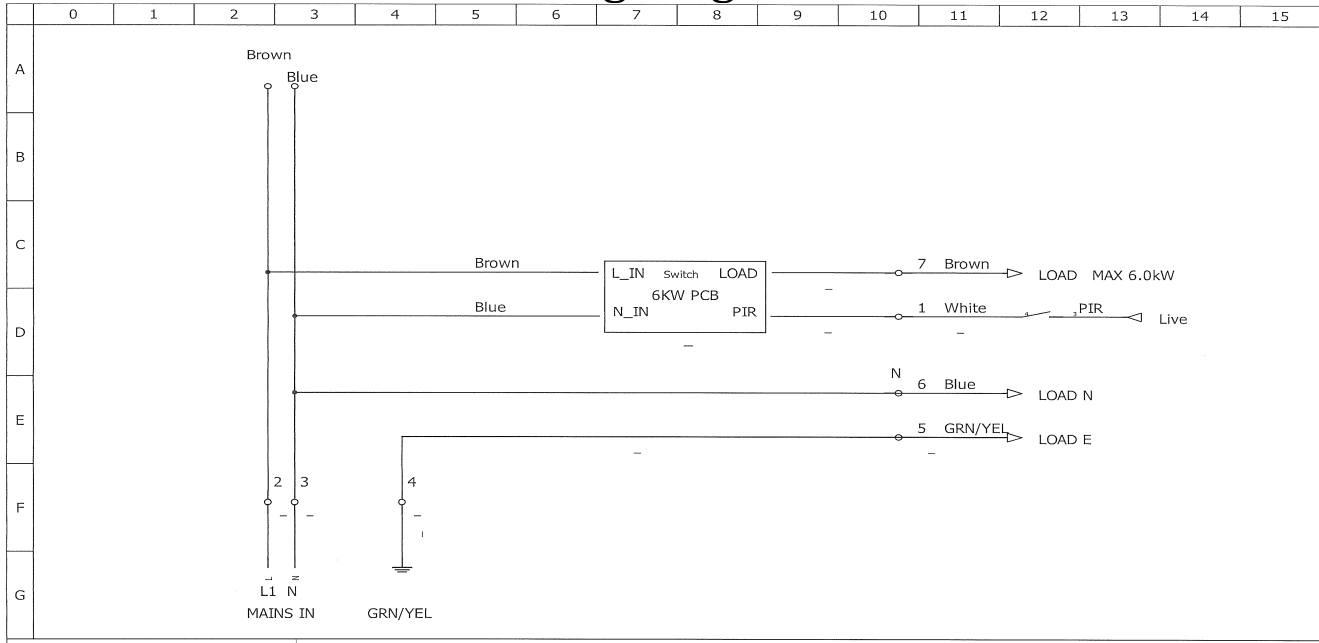

Author: Victor
 Date: 04/05/2021
 QHC06MR 6KW Remote controller
 File: QHC6MR_6KW
 Folio: 1/1

Wiring diagram for 6kW & 9kW controllers.

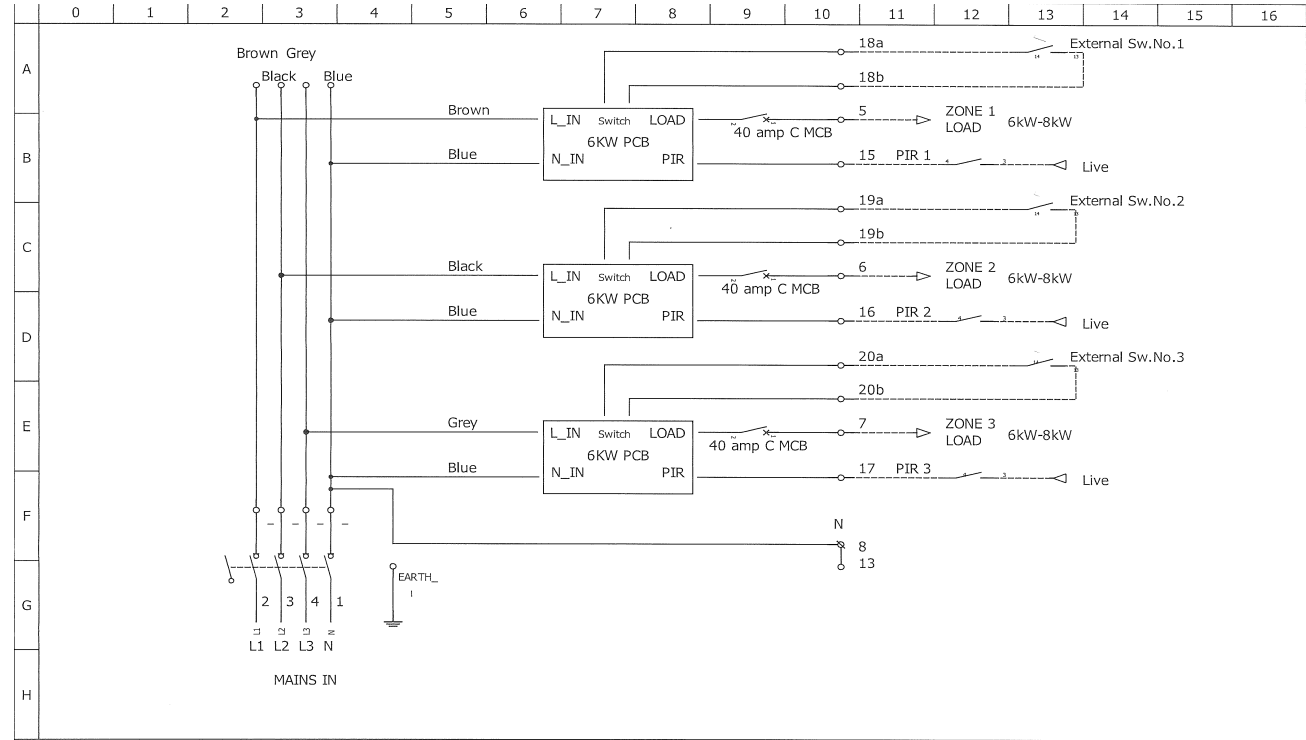

Author: Victor
 Date: 04/05/2021
 18-24KW Connection QHC18M-24M
 File: 18_24KW_Connection
 Folio: 1/1

Wiring diagram for 18kW, 24kW & 27kW controllers.

Important only a qualified electrician can install this device.

**Remember to fit C-curve MCB or RCBO circuit breakers
 or a fused spur for each heater.**

Flickering - J17 Red jumper link



Fig 23 QHPCB-A

If the user experiences flickering of lights after the system is installed.

The cause is as follows,

(1) The power control is accomplished by omitting half mains cycles, this is done to ensure no electromagnetic interference.

(2) On occasions when a half cycle is switched off it can cause a small voltage change on the mains wires which can be seen on some types of lights.

The solution is as follows below

You can move the Red jumper link to positions 2&3 on the header marked J17 on all 3 printed circuit boards QHPCB-A, see fig 23. This limits control levels to 50% & 100% which cannot be seen on any type of light.

The default setting for the Controller is with the Red jumper link in positions 1&2 and should be left in this location for normal operation.

When J17 is set in the default position all four power levels will function as normal. However, when set in positions 2 & 4 only power levels 2 & 4 will function.



QHC18M-3Z
Manual 3 zone



www.factron.ie

Products within this range



18kW 3 phase Manual Heater Controller QHC18M

The QHC18M, QHC24M & QHC27M are manual 3 phase heater control panels with load capacities of 18kW, 24kW & 27kW across 3 channels.

Save up to 60% of your energy costs by using the 4 power levels 1-4.

The controllers are fitted with an Isolation switch for the incoming 3 phase supply and for circuit protection MCB's are fitted on the three channels.

There are additional facilities for a timer function via auxiliary inputs for external switches NO(normally open) to close contacts.

There are also inputs for a mains switched (trigger) voltage for use with PIR motion detectors or an external 7-Day programmable timer.

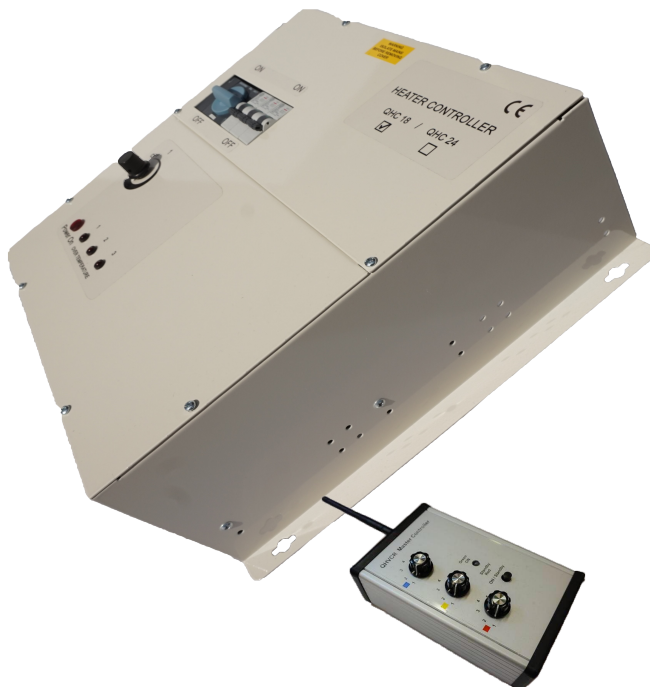

18kW 3 phase RF Heater Controller (receiver) QHC18MR

The QHC18MR, QHC24MR & QHC27MR are remotely controlled 3 phase RF heater control panels with load capacities of 18kW, 24kW & 27kW across 3 channels. These controllers can be operated manually or remotely via the selector dial on the front panel. When set in remote mode this device is controlled by the QHVCR 3 Zone wireless Master controller.

Save up to 60% of your energy costs by using the 4 power levels 1-4.

The controllers are fitted with an Isolation switch for the incoming 3 phase supply and for circuit protection MCB's on the three channels.

There are additional facilities for a timer function via auxiliary inputs for external switches NO(normally open) to close contacts. There are also inputs for a mains switched (trigger) voltage for use with PIR motion detectors or an external 7-Day programmable timer.

Note: The transmitter QHVCR is sold separately & is not included in the price of the QHC18MR.



**12kW 3 phase RF Heater Controller (receiver)
QHC12MRE**

The QHC12MRE is a wireless RF receiver which controls the power to Infrared heaters up to a load capacity of 12kW. This device is paired with the QHVCR 3 Zone remote Master Controller. Any number of these devices can be in a zone as long as they are within the 100 meter transmit range.

3 Phase controller

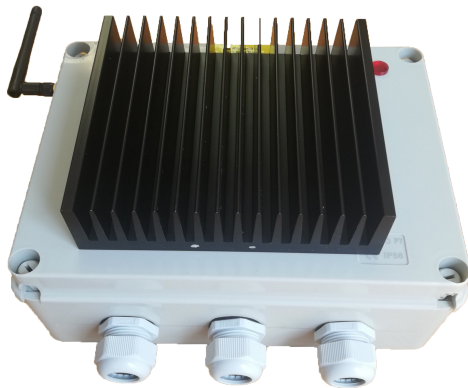

**9kW Single phase RF Heater Controller (receiver)
QHC09MRE**

The QHC09MRE is a wireless RF receiver which controls the power to Infrared heaters up to a load capacity of 9kW. This device is paired with the QHVCR 3 Zone remote Master Controller. Any number of these devices can be in a zone as long as they are within the 100 meter transmit range.

Single phase controller

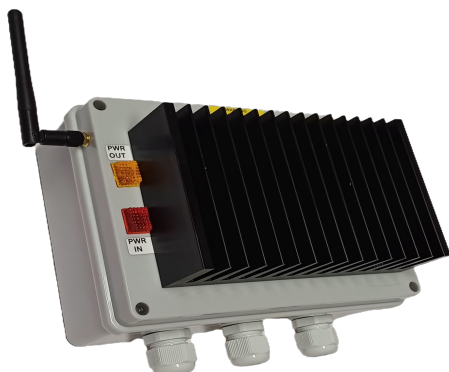

**6kW Single phase RF Heater Controller (receiver)
QHC06MRE**

The QHC06MRE is a wireless RF receiver which controls the power to Infrared heaters up to a load capacity of 6kW. This device is paired with the QHVCR 3 Zone remote Master Controller. Any number of these devices can be in a zone as long as they are within the 100 meter transmit range.

Single phase controller

3 Zone RF Master Controller (transmitter) QHVCR



The QHVCR is a wireless RF transmitter used to control any of our remote heater controllers QHC06MR up to QHC27MR & MRE units.

There are 3 zones Blue, Yellow & Red with five power settings Off to 4 . Setting 1 is the minimum and 4 the highest. This device will control several receivers in each zone provided they are within the Transmit range of 100 meters. This range can be extended to if required.

This unit is battery powered and requires 3 x AAA batteries & comes in a wall mounted version which is supplied as standard.

**Remember to fit C-curve MCB or RCBO circuit breakers
or a fused spur for each heater.**

Notes

Recommended protection devices which can be used with any QHC controller

C-curve double module RCBO's should be used

Product data sheet
AD982J

:hager

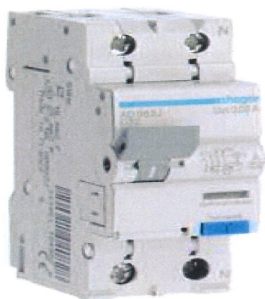

RCBO 1P+N 6kA C-32A 30mA A Class

AD982J

Technical Properties	
Rating current 30°C	32 A
Number of poles	2 P
Curve	C
Number of modules	2
Rated operational voltage Ue	240 V
Frequency	50 Hz
Height of installed product	83 mm
Depth of installed product	68 mm
Residual current type	A
Standard text	EN 61009-1

C-curve single module MCB's should be used

Product data sheet
MU132A

:hager



MCB 1P 6kA C-32A 1M

MU132A

Technical Properties	
Rating current 30°C	32 A
Number of poles	1 P
Curve	C
Number of modules	1
Rated operational voltage Ue	230 / 400 V
Frequency	50/60 Hz
Height of installed product	83 mm
Depth of installed product	70 mm
Standard text	IEC 60898-1



Factron
A BETTER SOLUTION

Unit 12 Ashbourne Ind. Park,
Ashbourne Co.Meath
A84 HY74
Ireland

CE Declaration of Conformity

QHC controllers

(LV Distribution panels) HS code 853710845

Product codes:

QHC06M, QHC06MRE, QHC09MRE, QHC12MRE, QHC18MRE,
QHC18M, QHC18M-3Z, QHC18MR, QHC24M, QHC24M-3Z, QHC24MR
QHC27M, QHC27M-3Z, QHC27MR

Comply with the harmonised standards and provisions of EC-Directives:

2006/95/EC – The Low Voltage Directive
2004/108/EEC – The Electromagnetic Compatibility Directive

We Factron Ltd declare the equipment named above complies with all the applicable essential requirements of the directives.

Signed by : *David Francis* on behalf of FACTRON LTD

Date : 08 / 07 / 2024



Supply voltage : Single phase 240v AC 50 Hz

Max. Load capacity : 6 kilo Watt

Input :	Live (Brown)	terminal #2
	Neutral (Blue)	terminal #3
	Earth in (Grn/Yel)	terminal #4

Input :	PIR input trigger	terminal #1
---------	-------------------	-------------

Output :	Switched Live out (Brown)	terminal #7
Soft start	Neutral return out (Blue)	terminal #6
	Earth out (Grn/Yel)	terminal #5

Transmission: RF 433mHz

Range : Antenna Standard	Up to 100 meters *(Line of sight)
Antenna Extended	Up to 200 meters *(Line of sight)

IP Rating: IP56

Dimensions : 200mm x 180mm x 120mm

Weight : 1.5 Kgs

**Remember to fit C-curve MCB or RCBO circuit breakers
or a fused spur for each heater.**



Tel. 00 353 1 8352718 Email: dave@factron.ie
Website: www.factron.ie